

 **PALMBERG**

SYSTO·TEC





 GERMAN
DESIGN
AWARD
SPECIAL
2017



Unser Klassiker · Our classic · Onze klassieker



Ein System – zwei Anmutungen

Ob Rundrohr oder Quadratrohr, verschweißte Seitenteile sorgen bei SYSTO-TEC zukünftig für noch mehr Stabilität bei der Arbeit. Konstruktive Elemente, wie die am Rahmen befestigten Verbindungsklammern, verleihen dem System dabei eine besondere Optik, ohne dabei aufdringlich zu sein.

One System – Two Impressions

Whether round tube or square tube, welded laterals will bring even more stability at work with SYSTO-TEC. Constructional elements, such as connecting clamps mounted at the frame, give the system a special, unpretentious appearance.

Eén systeem – twee indrukken

Ronde of vierkante poten, gelaste zijdelen bij SYSTO-TEC zorgen in de toekomst voor nog meer stabiliteit tijdens het werk. Constructieve elementen, zoals de aan het frame bevestigde verbindingsklemmen, geven het systeem een bijzondere look zonder dat het daarbij in het oog springend is.







Formvollendet und funktional

Perfect in form and function

Perfect en functioneel

SYSTO-TEC ist ein Teamplayer, der durch viele sinnvolle Zusatzkomponenten die kommunikative Büroarbeit unterstützt. Das Tischsystem besticht durch den klaren Aufbau der Grundkomponenten und steht dabei auf 60 mm starken Rundrohren. Damit Sie verspannungsfrei arbeiten können, ist es möglich die Tischhöhe über die herausdrehbaren Stellelemente von 680 auf 760 mm zu verstellen.

SYSTO-TEC is a team player that supports communicative office work by a lot of useful additional elements. The desk system captivates with the clear construction of the basic components and stands on 60 mm circular tubes. It is possible to adjust the table height from 680 to 760 mm via twistable standing elements so that you are able to work free of tensions.

SYSTO-TEC is een teamplayer, die door vele nuttige extra componenten de communicatie in de kantooromgeving ondersteunt. Het bureausysteem is uiterest stabiel door de eenvoudige constructie van de basiscomponenten en staat daarbij op 60 mm sterke ronde poten. Om er voor te zorgen dat u ontspannen kunt werken, is het mogelijk om de bureauhoogte door middel van uitdraaibare steldoppen van 680 tot 760 mm te verstellen.

vertikale Kabelführung · vertical cable conduit ·
verticale kabelgeleiding





Chrom Matt · Chrome Matt · Chroom Mat



Chrom Glanz · Chrome Glossy · Chroom Glans



Schwarz · Black · Zwart

Höheneinstellung durch
Stellelemente
Height adjustment by standing
elements
Instelbare hoogte door
steldoppen





Für die richtige Entscheidung am Arbeitsplatz

For the right decision in the workplace

Voor de juiste beslissing op de werkplek





Ergonomisch und variabel bleibt man bei SYSTO-TEC auch mit der Rohr-in-Rohr Variante. Diese Gestellform ermöglicht dem Nutzer eine Höheneinstellung zwischen 650 und 850 mm. In Verbindung mit Sideboards der Serie SELECT werden so aus Ihren Räumen inspirierende Arbeitswelten.

Also the tube-in-tube variant keeps you ergonomic und variable with SYSTO-TEC. This type of frame allows the user a height adjustment between 650 and 850 mm. In combination with sideboards of the SELECT series, your rooms are becoming inspiring working worlds.

Ergonomisch en flexibel blijft men ook met de SYSTO-TEC buis-in-buis oplossing. Dit onderstel maakt het voor de gebruiker mogelijk om een hoogte tussen 650 en 850 mm in te stellen. In combinatie met sideboards van de serie SELECT worden uw ruimtes zo inspirerende werkplekken.



Qualität, die ineinander greift
Quality that interlocks · Kwaliteit, die verbindt





Furnier Amerikanische Kirsche
Veneer American Cherry
Fineer Amerikaanse Kersen

Neben seiner enormen Stabilität bietet SYSTO-TEC vielfältige Lösungen für den Büroalltag. Ob konzentrierte Einzelarbeit, kommunikative Teamarbeit oder große Konferenzlösung, bei SYSTO-TEC wird das sachlich-elegante Erscheinungsbild des Tischsystems immer erkennbar beibehalten.

Along with its enormous stability, SYSTO-TEC offers a wide range of solutions for the daily office life. Whether focused individual work, communicative teamwork or large-scale conference solution, SYSTO-TEC always recognizably maintains the functional-elegant appearance of the desk system.

Naast zijn enorme stabiliteit biedt SYSTO-TEC veelzijdige oplossingen voor het leven op kantoor. Of het gaat om geconcentreerd werk, communicatieve samenwerking of grote conferenties, bij SYSTO-TEC wordt de zakelijk-elegante uitstraling van de meubelsysteem altijd herkenbaar gehandhaafd.







Arbeit im Quadrat

Die Vielfalt des Systems SYSTO-TEC ermöglicht es Ihnen, Tischbeine mit quadratischem Querschnitt auszuwählen. Die Quadrat-Rohr-Variante vermittelt dabei eine völlig neue Optik, gradlinig, stabil und klar.

Work in a Square

The diversity of the SYSTO-TEC system allows you to select table legs with a square cross-section. The square-tube-variant is conveying an entirely new appearance in this way, straight-line, stable and clear.

Rechtlijnig Werken

Dankzij de diversiteit van het SYSTO-TEC systeem is het mogelijk om tafelpoten met een vierkante poot te kiezen. De vierkante poot-variant brengt een volledig nieuwe look; rechtlijnig en stabiel.



Durch die klare konzeptionelle Ausrichtung passt sich SYSTO-TEC ohne Probleme an Ihre individuellen Arbeitsbedingungen an. Das stabile Tischsystem lässt sich dabei durch zusätzliche Adaptionen für den jeweiligen Funktionsbereich optimal erweitern.

By its clear conceptual approach, SYSTO-TEC easily adapts itself to your individual working conditions. The stable desk system can be optimally extended by additional adaptations for the respective functional area.

Door de duidelijke conceptuele geheel, past SYSTO-TEC zich zonder problemen aan uw individuele werkwijze aan. Het stabiele meubelsysteem laat zich dankzij extra aanpassingen voor elke gewenste functie optimaal uitbreiden.



Schiebplattenbeschlag
Sliding plate fitting
Schuifbladbeslag



CPU-Halter
CPU-Holder
PC-houder

Offen für Ihre Wünsche

Open to your requests · Open voor uw wensen





Sachlich, elegant und zeitgemäß

Functional, elegant and contemporary

Zakelijk, elegant en eigentijds



SYSTO-TEC überzeugt alle, die Wert auf Qualität, Optik und eine zeitgemäße Bürolösung legen. Die perfekte Kombination aus Form und Funktion bietet dabei die Grundlage für eine professionelle und motivierende Arbeitsatmosphäre.



SYSTO-TEC convinces anyone who attaches importance to quality, visual appearance and a contemporary office solution. The perfect combination of form and function provides the basis for a professional and motivating working atmosphere.

SYSTO-TEC overtuigt iedereen die waarde hecht aan kwaliteit, uitstraling en een eigentijdse kantooroplossing. De perfecte combinatie van vorm en functie biedt de basis voor een professionele en motiverende werkomgeving.

Erfolgreiche Gespräche sind planbar

Successful meetings are predictable

Succesvolle gesprekken worden voorspeld



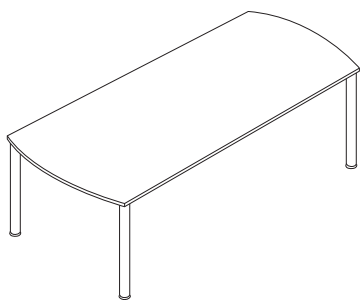
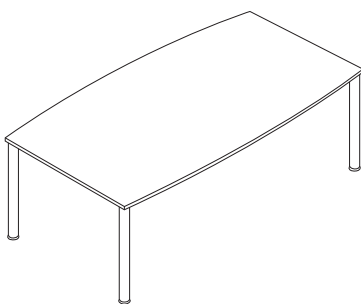
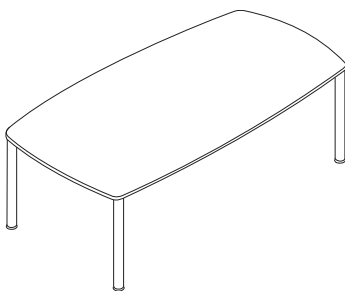
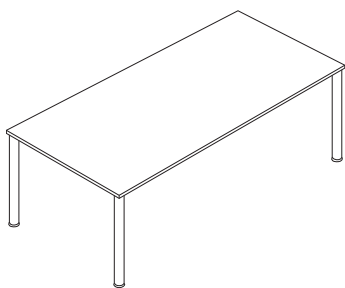

SYSTO-TEC bietet für jede Kommunikation die passende Lösung. Egal, welche Tischform Sie wählen, SYSTO-TEC ermöglicht eine nutzergerechte Anpassung für Ihre Gespräche.

SYSTO-TEC offers the suitable solution for each situation. Whatever shape of table you choose, SYSTO-TEC permits a user-oriented adjustment for your discussions.

SYSTO-TEC biedt voor elke vorm van communicatie de passende oplossing. Ongeacht welke tafelvorm u kiest, SYSTO-TEC maakt gebruiksvriendelijke aanpassingen voor uw gesprek mogelijk.



Dekore · Decors · Decors 19 / 25 mm



Ahorn
Maple
Ahorn



Akazie
Acacia
Acacia



Eiche Natur
Natural Oak
Eiken Natuur



Buche Gedämpft
Beech Muted
Gedempt Beuken



Birnbaum
Pear
Peren



Toskanischer Nussbaum
Tuscan Walnut
Toskaans Noten



Teak Rubin
Teak Ruby
Teak Rubin



Merano



Nussbaum Natur
Natural Walnut
Noten Natuur



Malaga Eiche
Malaga Oak
Malaga Eik

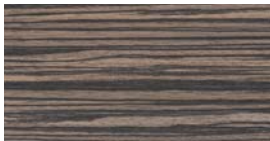

Zebrano

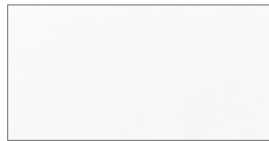

Superweiß
Super White
Superwit

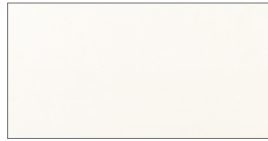

Porzellanweiß
Porcelain White
Porseleinwit



Grau Perl
Grey Pearl
Grijs Parel

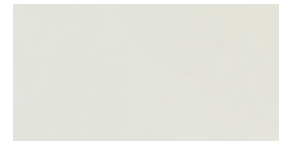

Hanf Perl
Hemp Pearl
Hanf Parel



Sandbeige
Sand Beige
Zandbeige



Alu Geschliffen
Aluminium Polished
Geslepen Aluminium

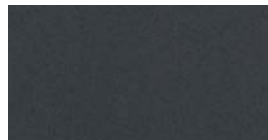

Anthrazit
Anthracite
Antraciet

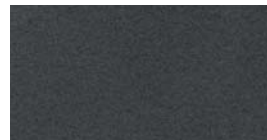

Anthrazit Perl
Anthracite Pearl
Antraciet Parel

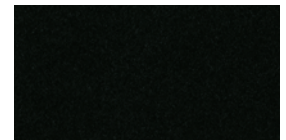

Vulkanschwarz
Volcano Black
Vulkaanzwart



MDF

Olivgrün (19mm)
Olive Green
Olijfgroen

Furnier · Veneers · Fineer 19 / 25 mm



Ahorn
Maple
Ahorn



Buche
Beech
Beuken



Eiche Natur
Natural Oak
Eiken Natuur



Birnbaum
Pear
Peren



Amerikanische Kirsche
American Cherry
Amerikaanse Kersen

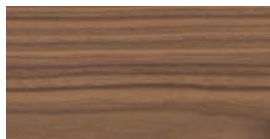

Nussbaum Natur
Natural Walnut
Noten Natuur



Wenge
Wenge
Wengé

Erfahrungsgemäß können Druckfarben nicht die Brillanz der Dekor- und Gestellfarben wiedergeben. Gern wird Ihr Händler Ihnen Originalmuster vorlegen · Experience shows that the colors presented do not display the brilliance of the real decor and frame finishes. Your dealer will be pleased to show you original samples · Uit ervaring blijkt dat geprinte kleuren niet de glans van de kleuren van de decors en onderstellen kunnen reproduceren. Uw dealer laat u graag de originele stalen zien.

Kompaktschichtstoff · Laminat · Volkern 12 mm



Ahorn
Maple
Ahorn



Buche Gedämpft
Beech Muted
Gedempt Beuken



Birnbaum
Pear
Peren



Merano

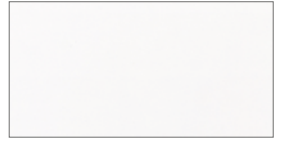

Superweiß
Super White
Superwit

Gestell, Schiebepplatten, Aufsatzblenden und Kabelkanal

Frame, Sliding plates, Attachment surrounds and Cable duct · Onderstel, schuifbladen, opzetwanden en kabelkanaal



Weiß Struktur
White Structure
Wit Structuur



Weißaluminium
White Aluminium
Wit Aluminium
RAL 9006

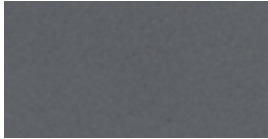

Anthrazit Metallic
Anthracite Metallic
Antraciet Metallic



Anthrazit Struktur
Anthracite Structure
Antraciet Structuur
RAL 7016



Schwarz Struktur
Black Structure
Zwart Structuur
RAL 9005

Außenrohr · Outer tube · Buitenste poot



Weiß Struktur
White Structure
Wit Structuur

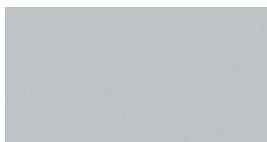

Weißaluminium
White Aluminium
Wit Aluminium
RAL 9006

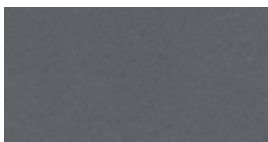

Anthrazit Metallic
Anthracite Metallic
Antraciet Metallic

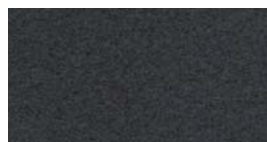

Anthrazit Struktur
Anthracite Structure
Antraciet Structuur
RAL 7016



Schwarz Struktur
Black Structure
Zwart Structuur
RAL 9005



Chrom Glanz
Chrome Glossy
Chroom Glans

Fußstopfen

Foot plugs · Steldoppen

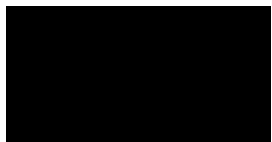

Schwarz
Black
Zwart
RAL 9011

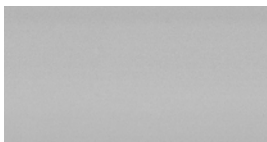

Chrom Matt
Chrome Matt
Chroom Mat



Chrom Glanz
Chrome Glossy
Chroom Glans

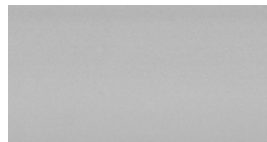

Chrom Matt
Chrome Matt
Chroom Mat



Chrom Glanz
Chrome Glossy
Chroom Glans

Verbindungsklammern

Connection clamps · Koppelklemmen

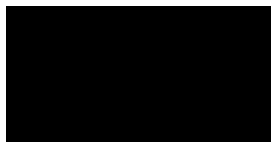

Schwarz
Black
Zwart
RAL 9011

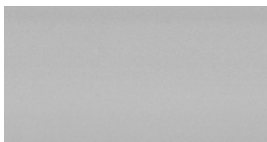

Chrom Matt
Chrome Matt
Chroom Mat



Chrom Glanz
Chrome Glossy
Chroom Glans

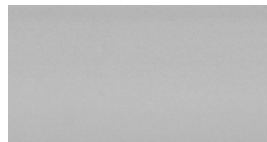

Chrom Matt
Chrome Matt
Chroom Mat



Chrom Glanz
Chrome Glossy
Chroom Glans



PRISMA 2

Ideen für Entscheidungen

Ideas for decisions · Ideeën voor beslissingen



SELECT

Neben dem System SYSTO-TEC bietet PALMBERG weitere hochwertige Arbeitsplatzsysteme an. Überzeugen Sie sich auf www.palmberg.de wie vielfältig moderne Büroarbeit sein kann.

Besides the SYSTO-TEC system, PALMBERG offers additional high-quality workplace systems. Find out for yourself at www.palmberg.de how diverse modern office work can be.

Naast het systeem SYSTO-TEC biedt PALMBERG ook andere hoogwaardige werkpleksystemen aan. Overtuigt u zich op www.palmberg.nl of www.palmberg.be, hoe veelzijdig modern kantoorwerk kan zijn.



PALMBERG Büroeinrichtungen + Service GmbH
Am Palmberg 9 · 23923 Schönberg
Tel. +49 38828 38-0 · Fax +49 38828 38-136
info@palmberg.de · www.palmberg.de

PALMBERG-Showroom Hamburg
Heidenkampsweg 82 · 20097 Hamburg

PALMBERG-Showroom Berlin
Aroser Allee 66 · 13407 Berlin

PALMBERG-Showroom Düsseldorf
Königsallee 61 · 40215 Düsseldorf

PALMBERG-Showroom Frankfurt
Frankfurter Str. 151 D · 63303 Dreieich
Eingabe Navigation: Benzstraße, 63303 Dreieich

PALMBERG-Showroom München
Lilienthalstr. 2a · 85399 Hallbergmoos

PALMBERG-Showroom Stuttgart
Gottlieb-Manz-Str. 1 · 70794 Filderstadt-Bernhausen

PALMBERG-Showroom Niederlande
Rietveldenweg 47 · 5222 AP 's-Hertogenbosch
Tel. +31 411 689522 · Fax +31 411 689479
info@palmberg.nl · www.palmberg.nl

PALMBERG (Schweiz) AG
Werkstrasse 17 · 8222 Beringen
Tel. +41 62 888 80 00 · Fax +41 62 888 80 09
info@palmberg.ch · www.palmberg.ch



www.facebook.de/palmberg.de

